

**FEATURES**

- Field-Bus remote data acquisition
- RS-485 Master/Slave communication type
- MODBUS RTU/ASCII
- 8 channel input
- Up to +/- 10V input
- Watch-Dog Alarm
- Remotely Configurable
- 2000 Vac 3-way Galvanic Isolation
- High Accuracy
- EMC compliance – CE mark
- DIN rail suitable mounting - EN-50022 compliance



**GENERAL DESCRIPTION**

The SS 3017 device is able to acquire up to 8 analog input signals. Data values are transmitted with MODBUS RTU/ASCII protocol on the RS-485 network (RS-232 interface is available).  
 It is possible to connect up to +/- 10V voltage signals.  
 By means of a 16 bit converter, the device guarantee a high accuracy and a stable measure versus time and temperature.  
 To ensure the plant safety, two Watch-Dog timer alarms are provided.  
 The 2000 Vac isolation between input, power supply and serial line removes eventual ground-loop effects, allowing the use of the device even in the heavy environmental conditions.  
 SS 3017 is in compliance with the 89/336/EEC directive on the electromagnetic compatibility.  
 The device is housed in a rough self-extinguishing plastic container which, thanks to its thin profile of 17.5mm only, allows a high density mounting on EN-50022 standard DIN rail.

**COMMUNICATION PROTOCOLS**

The SS3017 is designed to work with the MODBUS RTU/ASCII protocol: standard protocol in field-bus; allows to directly interface SS3000 series devices to the larger part of PLCs and SCADA applications available on the market.  
 For the protocol instructions, see the relative User Guide.

**USER INSTRUCTIONS**

Before to install the device, please read the "Installation Instruction" section.  
 If the module configuration is unknown, it can be hardly to establish a communication with them; connecting the INIT terminal to the GND terminal (ground), at the next power-up the device will be auto-configured in the default settings (see Operating User Guide).  
 Connect power supply, serial bus and analog inputs as shown in the "Wiring" section.  
 The "PWR" LED state depending to the working condition of the device: see the "Light Signalling" section to verify the device working state.  
 To perform configuration and calibration operations, read the instructions in the Operating User Guide.  
 To simplify handling or replacing of the device, it is possible to remove the wired terminals even with the device powered.

**TECHNICAL SPECIFICATIONS (Typical @ 25 °C and in the nominal conditions)**

Input type	Min	Max				
<b>Voltage</b> 10 V	-10 V	+10 V	<b>Input Calibration (1)</b> +/- 10 mV	<b>Power Supply</b>		
			<b>Linearity (1)</b> V +/-0,1%	Supply Voltage	10 .. 30 Vdc	
			<b>Input Impedance</b> V > 100 KΩ	Current consumption	30 mA @ 24 Vdc	
			<b>Thermal drift (1)</b> Full Scale ± 0.005 % / °C	Polarity inversion protection	60 Vdc max	
			<b>Rise time</b> 0.5 ÷ 2 sec.	<b>Isolation</b>		
			<b>Data Transmission</b>	Input – RS485	2000 Vac 50 Hz, 1 min.	
			Baud Rate 38.4 Kbps	Supply – Input	2000 Vac 50 Hz, 1 min.	
			Max distance 1.2 Km	Supply – RS485	2000 Vac 50 Hz, 1 min.	
			<b>Warm-up time</b> 3 min.	<b>Temperature &amp; Humidity</b>		
				Operating temperature	-10°C .. +60°C	
				Storage temperature	-40°C .. +85°C	
				Humidity (non condensing)	0 .. 90 %	
				<b>Housing</b>		
				Material	Self-extinguishing plastic	
				Mounting	EN-50022 DIN rail	
				Weight	~ 150 g.	
				<b>EMC</b>		
				Immunity	EN 61000-6-2	
				Emission	EN 61000-6-4	
			(1) Referred to input Span (difference between max. and min. values)			

## INSTALLATION INSTRUCTIONS

The SS 3017 device is suitable for fitting to DIN rails in the vertical position. For optimum operation and long life follow these instructions:

**When the devices are installed side by side it may be necessary to separate them by at least 5 mm in the following case:**

- If panel temperature exceeds 45°C and at least one of the overload conditions exist.

Make sure that sufficient air flow is provided for the device avoiding to place raceways or other objects which could obstruct the ventilation slits. Moreover it is suggested to avoid that devices are mounted above appliances generating heat; their ideal place should be in the lower part of the panel. Install the device in a place without vibrations.

Moreover it is suggested to avoid routing conductors near power signal cables (motors, induction ovens, inverters etc...) and to use shielded cable for connecting signals.

## CABLING

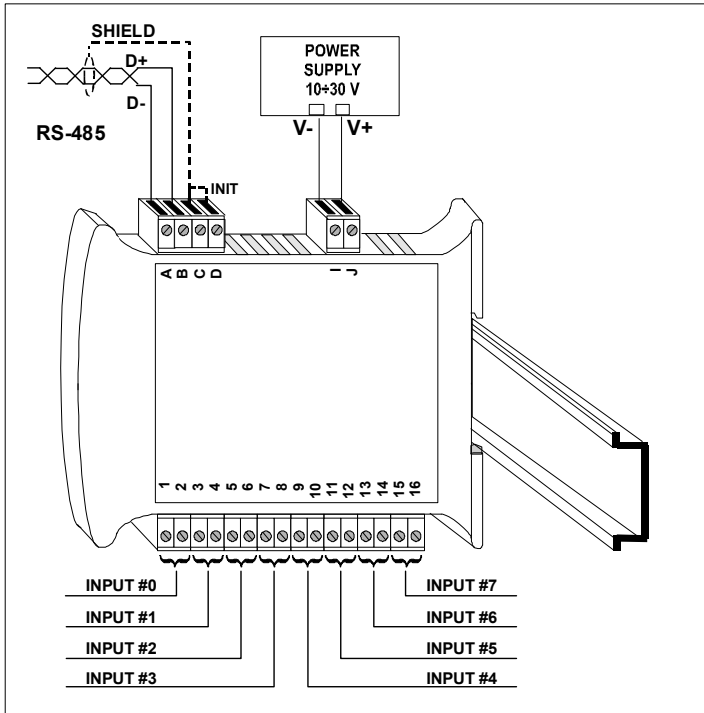

## LIGHT SIGNALLING

LED	COLOUR	STATE	DESCRIPTION
PWR	GREEN	ON	Device powered
		OFF	Device not powered / Wrong RS-485 cabling.
		FAST BLINK	Communication in progress (blink frequency depends to baud-rate)
		1 second BLINK	Watch-Dog Alarm condition

## MECHANICAL DIMENSIONS (mm)

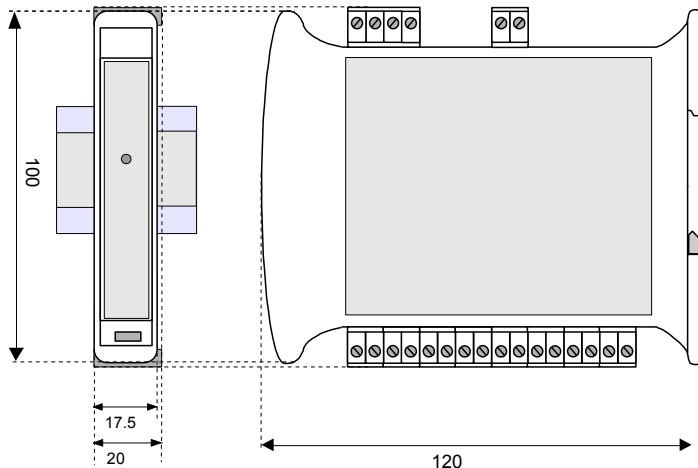

## WIRING

### ANALOG INPUT WIRING

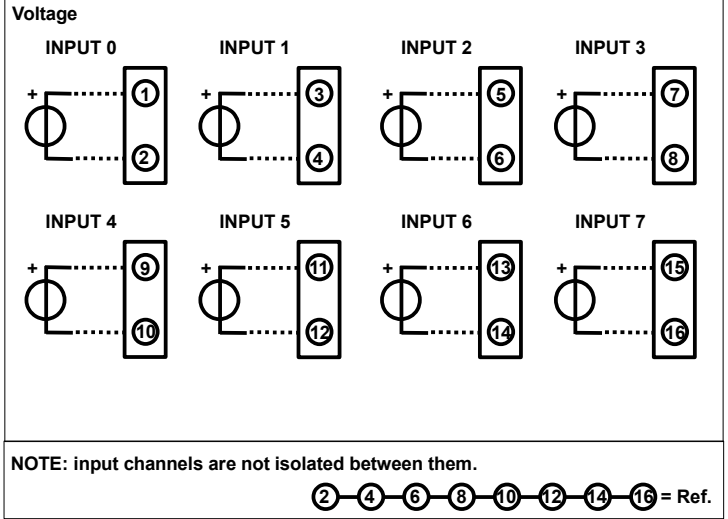

### RS-485 NETWORK WIRING

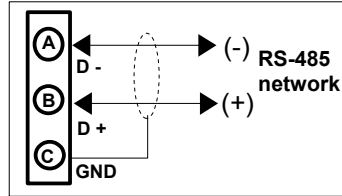

### RS-232 NETWORK WIRING

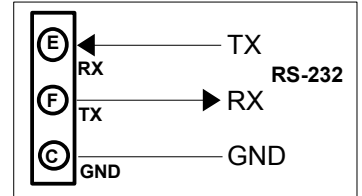

### POWER SUPPLY WIRING

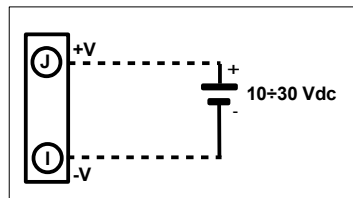

### INIT WIRING

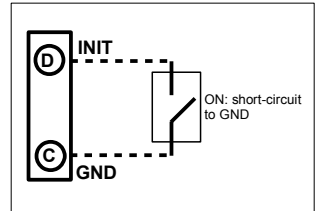

## ISOLATION DIAGRAM

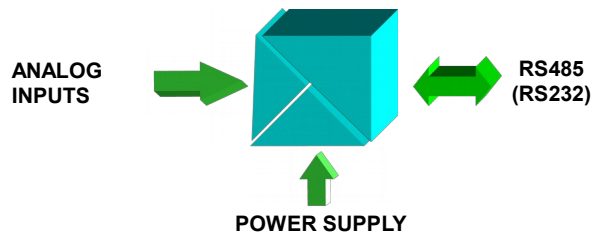

### HOW TO ORDER

In the order phase, it is mandatory to specify the interface type (RS485 or RS232). SS3017 can be supplied with the configuration specified by the customer. Please refer to the "Technical Specification" section for the output type available.

### ORDER CODE:

SS 3017-V / M / 485

Protocol type  
M: MODBUS protocol.

Interface type  
485 : RS-485  
232 : RS-232

■ = Requested  
□ = Optional