

**FEATURES**

- Field Bus data acquisition
- Master/Slave communication on RS-485 network
- MODBUS RTU/ASCII protocol or ASCII protocol
- 8 + 4 (optional) digital inputs
- Watch-Dog alarm
- Four ways galvanic isolation 2000 Vac
- High accuracy
- EMC compliance – CE Mark
- In compliance to EN-50022 DIN rail mounting



**GENERAL DESCRIPTION**

The device SS 3148 is able to acquire up to 12 digital inputs. The data are transmitted with MODBUS RTU/ASCII on RS-485 network. The 2000 Vac galvanic isolation between inputs, power supply and RS-485 serial line cancels any ground-loop effect noise, allowing the use of the device in worst ambient conditions. The SS 3148 is in compliance to the 89/336/EEC directive on the electromagnetic compatibility. The SS 3148 is housed in a rough self-extinguishing plastic enclosure of 17,5 mm thickness, suitable for EN 50022 standard DIN rail.

**COMMUNICATION PROTOCOLS**

On the SS3000 modules are implemented the following communication protocols:  
**MODBUS RTU/ASCII Protocol:** one of the most used standard communication protocol; it permit to interface the modules of SS3000 series directly to the greater part of PLC and SCADA software available on the market. For communication setting, refer to the User manual.

**OPERATING INSTRUCTIONS**

Before to install the device, please read carefully the "Installation instructions" section. If the correct configuration of the device is unknown, could be impossible to establish a communication with the device; connecting the INIT terminal to the GND terminal, when the devices is power-on, it goes automatically to the default configuration (see the User Manual). Connect the power supply, the serial bus and the I/O signals as shown in the "Wiring" section. The "PWR" LED, changes its state in function of the working condition of the device: please refer to the "Light signalling" to verify the correct working of the device. To make easy the maintenance or the substitution of the device, it is possible the "hot swap" of the terminals.

**TECHNICAL SPECIFICATIONS (Typical @ 25 °C and under nominal conditions)**

<p><b>Digital Inputs</b></p> <p>Channels            8 + 4 (optional)</p> <p>Input voltage (bipolar)</p> <p>OFF State           0 ÷ 3 V</p> <p>ON State            10 ÷ 30 V</p> <p>Impedance           4,7 KΩ</p>	<p><b>Power supply</b></p> <p>Supply Voltage        10 .. 30 Vdc</p> <p>Current consumption   35 mA @ 24 Vdc</p> <p>Reverse Polarity protection   60 Vdc max</p> <p><b>Isolation Voltage</b></p> <p>Inputs 0÷7 – Inputs 8÷11    1500 Vca 50 Hz, 1 min.</p> <p>Inputs – RS485            2000 Vca 50 Hz, 1 min.</p> <p>Inputs – Supply            2000 Vca 50 Hz, 1 min.</p> <p>RS-485 – Supply            2000 Vca 50 Hz, 1 min.</p>
<p><b>Sample time</b>            20 ms</p> <p><b>Data Transmission (async. serial)</b></p> <p>Baud rate                up to 115.2 Kbps</p> <p>Max. Distance            1,2 Km – 4000 ft.</p>	<p><b>Temperature &amp; Humidity</b></p> <p>Operating Temperature    -10°C .. +60°C</p> <p>Storage Temperature       -40°C .. +85°C</p> <p>Non-condensing Humidity   0 .. 90 %</p> <p><b>Enclosure</b></p> <p>Material                    self-extinguishing plastic</p> <p>Mounting                    EN-50022 DIN rail</p> <p>Weight                      about 150 g.</p> <p><b>EMC</b></p> <p>Immunity                    EN 61000-6-2</p> <p>Emission                    EN 61000-6-4</p>

## INSTALLATION INSTRUCTIONS

The device SS 3148 is suitable to be mounted on DIN rail, in vertical position. For a correct working and a long life of the device, read the following indications.

**In case of the devices are mounted side by side, please leave about 5mm between in the following situations:**

- Temperature in the cabinet higher than 45 °C and high supply voltage (>27Vdc).

Avoid to place raceways or other objects which could obstruct the ventilation slits. It is suggested to avoid that devices are mounted above appliances generating heat; their ideal place should be in the lower part of the panel.

Avoid to install the devices in a site where vibrations are present.

It is recommended to use shielded cable for connecting signals. The shield must be connected to an earth wire provided for this purpose. Moreover it is suggested to avoid routing conductors near power signal cables.

## CABLING

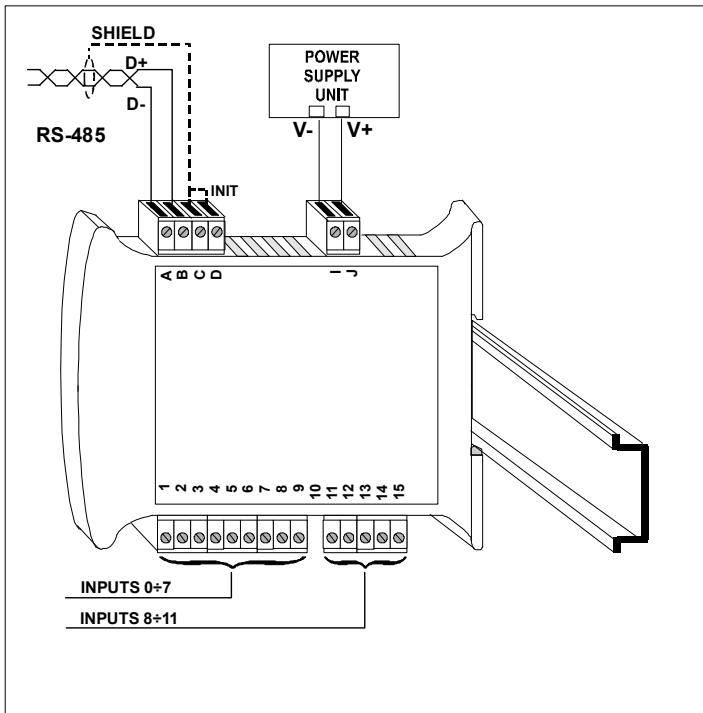

## LIGHT SIGNALLING

LED	COLOUR	STATE	DESCRIPTION
PWR	GREEN	ON	Device powered
		OFF	Device not powered or wrong RS-485 connection
		RAPID BLINK	Communication in progress (the blink frequency depends to the Baud-rate)
		SLOW BLINK	~1 sec. - Watch-Dog Alarm condition

## MECHANICAL DIMENSIONS (mm)

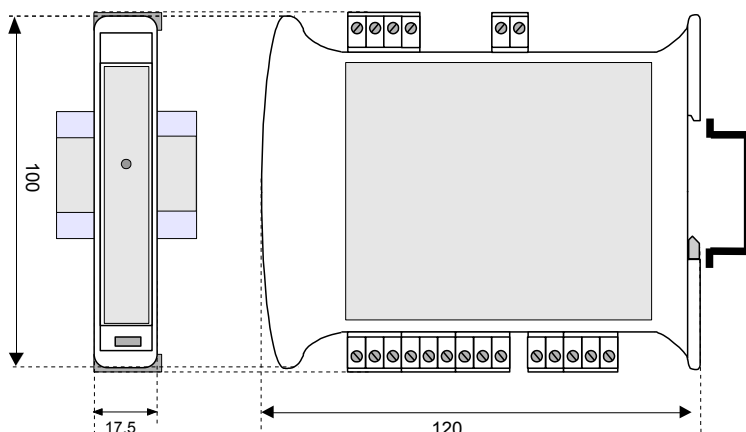

## WIRING

### DIGITAL INPUT WIRING

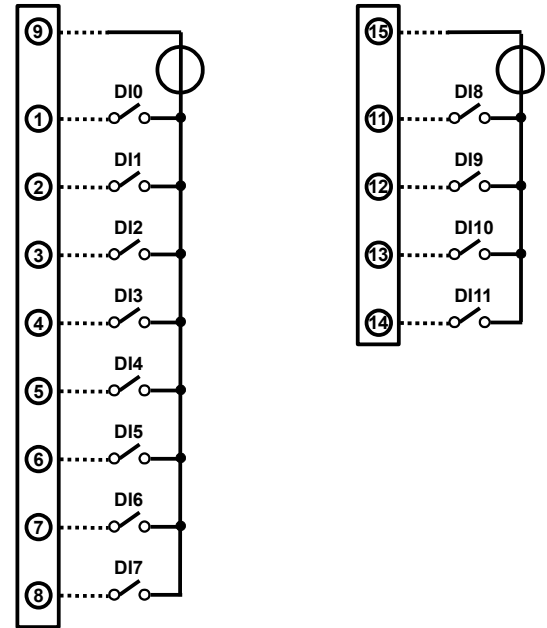

NOTES: Input channels 0÷7 are insulated from input channels 8÷11

### RS-485 NETWORK WIRING

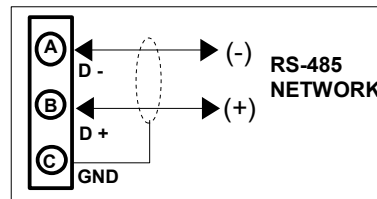

### INIT WIRING

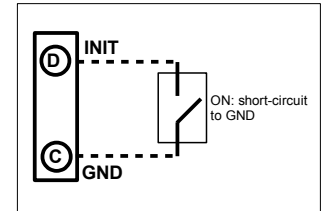

### POWER SUPPLY WIRING

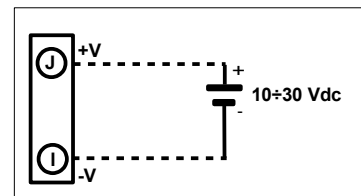

### ISOLATION DIAGRAM

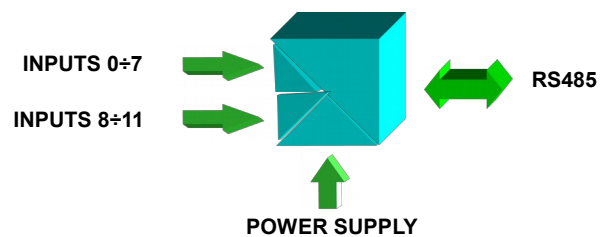

### HOW TO ORDER

In the order phase it is mandatory to specify the protocol type (MODBUS or ASCII).

SS 3148 / **M**

Protocol type  
M: MODBUS.  
A: ASCII.

■ = Mandatory  
□ = Optional